

# Candidate Marks Report

*Series : 6 2018*

This candidate's script has been assessed using On-Screen Marking. The marks are therefore not shown on the script itself, but are summarised in the table below.

---

Centre No :	Assessment Code :	H556
Candidate No :	Component Code :	01
Candidate Name :		

---

Total Marks :

In the table below 'Total Mark' records the mark scored by this candidate.  
'Max Mark' records the Maximum Mark available for the question.

## SECTION A

You should spend a maximum of 30 minutes on this section.

Write your answer to each question in the box provided.

Answer all the questions.

1 Which of the following units is **not** an S.I. base unit?

- A ampere
- B mole
- C volt
- D kilogram

Your answer

C

[1]

2 Which set of quantities are all scalar?

- A acceleration, displacement, velocity
- B energy, mass, power
- C extension, force, gravitational potential energy
- D weight, kinetic energy, work done

Your answer

B

[1]

3 A metal block of mass 0.28 kg has an initial temperature of 82 °C. It is dropped into cold water. The temperature of the block after 1.2 minutes is 20 °C. The specific heat capacity of the metal is 130 J kg<sup>-1</sup> K<sup>-1</sup>.

What is the average thermal power transferred away from the metal block?

- A 31 W
- B 41 W
- C 1900 W
- D 2700 W

Your answer

A

[1]



4 The acceleration  $a$  of a simple harmonic oscillator is related to its displacement  $x$  by the equation

$$a = -25x.$$

What is the frequency of the oscillator?

$2\pi f = 25$   
3.91

- A 0.80 Hz
- B 1.3 Hz
- C 4.0 Hz
- D 5.0 Hz

Your answer C

[1]

5 *The centre of a* A rod is fixed to a pulley. Two 50 N forces are applied to the ends of the rod as shown. The tension in the rope attached to the pulley is  $T$ . The system is in equilibrium.

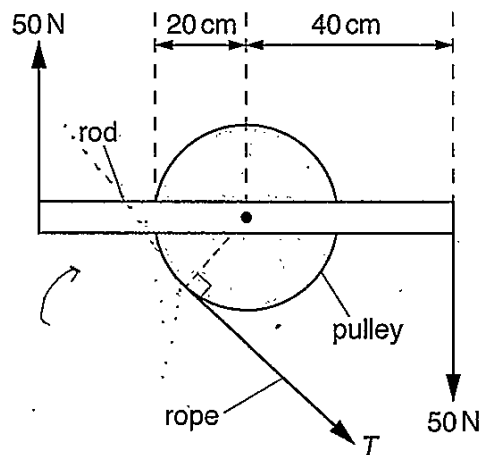

*40mm*

Not to scale

What is the moment of the tension  $T$  about the centre of the pulley?

- A 10 Nm
- B 20 Nm
- C 30 Nm
- D 40 Nm

Your answer D

[1]



- 6 The latent heat of vaporisation of a liquid is  $2300 \text{ kJ kg}^{-1}$  and it has a molar mass of  $0.018 \text{ kg mol}^{-1}$ .

What is the energy required to change 30 moles of the liquid to gas?

- A  $4.1 \times 10^4 \text{ J}$   
 B  $1.2 \times 10^6 \text{ J}$   
 C  $6.9 \times 10^7 \text{ J}$   
 D  $3.8 \times 10^9 \text{ J}$

$$n = \frac{M}{M_r}$$

Your answer

B

[1]

- 7 One end of a spring is fixed and a force  $F$  is applied to its other end. The elastic potential energy in the extended spring is  $E$ . The spring obeys Hooke's law.

What is the extension  $x$  of the spring?

- A  $x = \frac{E}{F}$   
 B  $x = \frac{F}{E}$   
 C  $x = \frac{2E}{F}$   
 D  $x = \frac{F}{2E}$

$$E = \frac{1}{2}Fx$$

$$E = \frac{1}{2}Fx$$

$$\frac{2E}{F} = x$$

Your answer

C

[1]



- 8 An electron makes a transition between the two energy levels shown below.

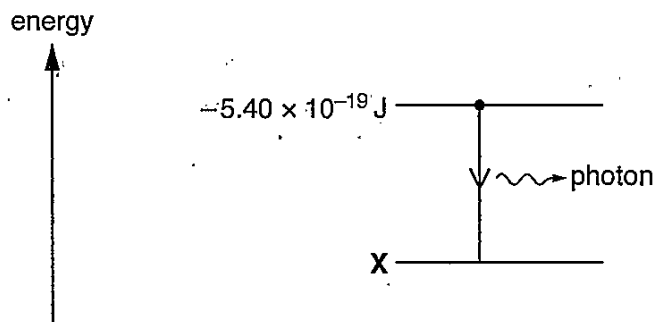

This transition produces a photon of frequency  $4.10 \times 10^{14} \text{ Hz}$ .

What is the value of the energy level X?

- A  $-2.68 \times 10^{-19} \text{ J}$   
 B  $-2.72 \times 10^{-19} \text{ J}$   
 C  $-5.40 \times 10^{-19} \text{ J}$   
 D  $-8.12 \times 10^{-19} \text{ J}$

$$E = hf$$

Your answer

A

[1]

- 9 A pendulum is oscillating in air and experiences damping.

Which of the following statements is/are correct for the damping force acting on the pendulum?

- 1 It is always opposite in direction to acceleration.  
 2 It is always opposite in direction to velocity. ✓  
 3 It is maximum when the displacement is zero. ✓

- A Only 1 and 2  
 B Only 2 and 3  
 C Only 3  
 D 1, 2 and 3

Your answer

B

[1]



- 10 A trolley of mass  $M$  is pulled along a horizontal table by a force  $W$  provided by a mass hanging from the end of a string as shown.

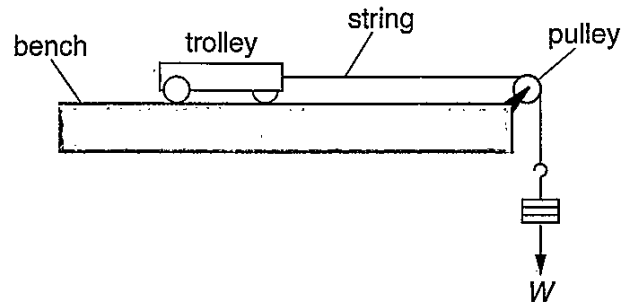

Frictional forces are negligible. The acceleration of free fall is  $g$ .

What is the correct equation for the acceleration  $a$  of the trolley?

A  $a = \frac{W}{M}$

B  $a = g$

C  $a = \frac{W}{2M}$

D  $a = \frac{W}{M + \frac{W}{g}}$

$F = mg$

$W = ma$

$\frac{W}{m} = a$

Your answer

A

[1]



- 11 The table below shows some data on two wires X and Y.

Wire	Young modulus of material/GPa	Cross-sectional area of wire/mm <sup>2</sup>
X	120	1.0
Y	200	2.0

The wires X and Y have the same original length. The tension in each wire is the same. Both wires obey Hooke's law.

What is the value of the ratio  $\frac{\text{extension of X}}{\text{extension of Y}}$ ?

- A 0.30  
B 1.7  
C 2.0  
D 3.3

$$\frac{\lambda}{\frac{\sigma}{E}L}$$

$$Y \times \frac{\lambda}{L} = Z$$

$$\lambda =$$

Your answer

B

[1]

- 12 An object is dropped from rest at time  $t = 0$ . It falls vertically through the air. The variation of the velocity  $v$  with time  $t$  is shown below.

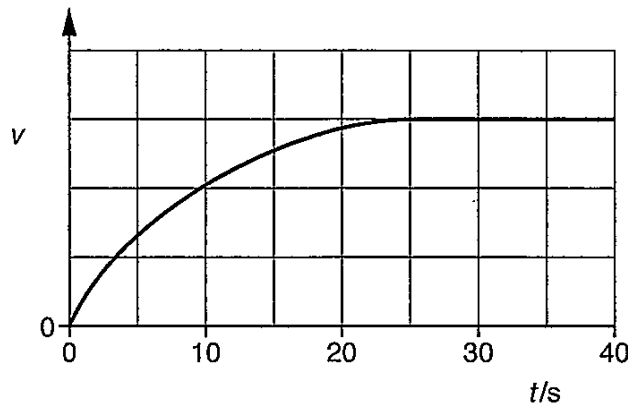

Which statement is correct about this object?

- A It has constant acceleration. ~~X~~  
B It experiences zero drag at  $t = 30$  s. ~~X~~  
C It has an acceleration of  $9.81 \text{ ms}^{-2}$  at  $t = 0$  s.  $\checkmark$   
D It travels the same distance in every successive 10 s. ~~X~~

Your answer

C

[1]



- 13 Earth has a mass of  $6.0 \times 10^{24}$  kg and a radius of 6400 km. A satellite of mass 320 kg is lifted from the Earth's surface to an orbit 1200 km above its surface.

What is the change in the gravitational potential energy of the satellite?

- A  $9.1 \times 10^2$  J  
 B  $9.9 \times 10^6$  J  
 C  $3.2 \times 10^9$  J  
 D  $3.8 \times 10^9$  J

Your answer

C

[1]

- 14 The volume of one mole of an ideal gas is  $V$ . The gas exerts pressure  $p$  and has thermodynamic temperature  $T$ .

Which of the following has the units  $\text{J mol}^{-1} \text{K}^{-1}$ ?

- A  $pV$   
 B  $\frac{p}{T}$   
 C  $\frac{V}{T}$   
 D  $\frac{pV}{T}$

$$pV = nRT$$

$$p = \frac{nRT}{V}$$

$$V = \frac{nRT}{p}$$

$$\frac{V}{T} = \frac{nR}{p}$$

Your answer

D

[1]

$$pV = nRT$$

$$\frac{pV}{T} = nR$$

$$R = 8.31 \text{ J mol}^{-1} \text{K}^{-1}$$





15 An object oscillates with simple harmonic motion.

Which graph **best** shows the variation of its potential energy  $E$  with distance  $x$  from the equilibrium position?

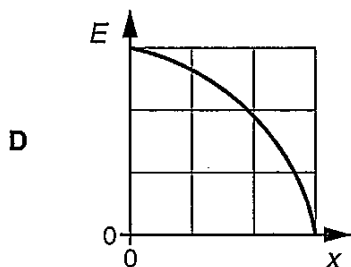
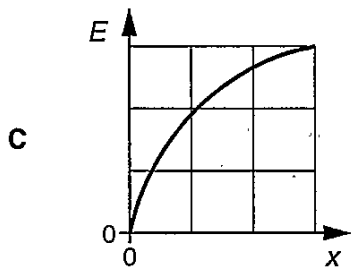
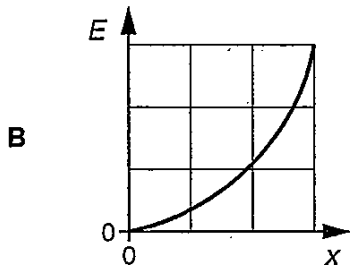
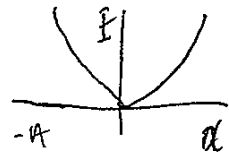
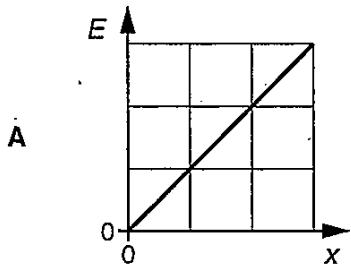

Your answer B

[1]



BLANK PAGE

PLEASE DO NOT WRITE ON THIS PAGE



## SECTION B

Answer all the questions.

- 16 (a) A tennis ball is struck with a racket. The initial velocity  $v$  of the ball leaving the racket is  $30.0 \text{ m s}^{-1}$  and it makes an angle of  $70^\circ$  to the horizontal as shown in Fig. 16. Air resistance is negligible

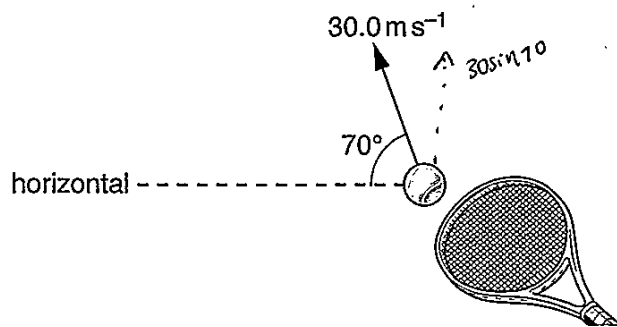

Fig. 16

- (i) Calculate the vertical component of the initial velocity of the ball.

$$30 \sin (70) = 28.1907 \\ = 28 \text{ m s}^{-1}$$

vertical component = 28 .....  $\text{m s}^{-1}$  [1]

- (ii) Use your answer in (i) to show that the ball reaches a maximum height  $h$  of about 40 m.

$$\begin{aligned} \uparrow \\ S &= ? \\ u &= 0 \\ v &= 30 \sin(70) = 28 \\ a &= -9.81 \\ t &= \end{aligned}$$

$$\frac{v^2 - u^2}{2a} = s$$

$$\frac{28^2}{2 \times 9.81} = 39.9592 \\ \sim 40 \text{ m.}$$

$h =$  40 ..... m [2]



- (iii) Explain why the kinetic energy of the ball is not zero at maximum height.

..... this is because it is still moving horizontally.....  
 ..... thus still has a ~~vertical~~ horizontal speed and ..... [1]  
 ..... thus a kinetic energy

- (iv) The mass  $m$  of the ball is 57.0g.

Calculate the kinetic energy  $E_k$  of the ball when it is at its maximum height.

$$\text{max height: } v = \text{horizontal component} \\ = 30 \cos 70$$

$$\frac{1}{2} \times 0.057 \times [30 \cos(70)]^2 = 3.00048 \\ \approx 3 \text{ J}$$

$$E_k = 3.0 \text{ J [2]}$$

- (b)\* A metal ball is rolled off the edge of a horizontal laboratory bench. The initial horizontal velocity of the ball is  $v$ . The ball travels a horizontal distance  $x$  before it hits the level floor.

Use your knowledge of projectile motion to suggest the relationship between  $v$  and  $x$ . Describe how an experiment can be safely conducted to test this relationship and how the data can be analysed.

..... AS there is no component of force in the horizontal direction,  
 ..... the ball will have a constant horizontal velocity. Therefore  
 ..... the distance travelled by the ball ( $x$ ) is equal to

.....  $v \times t$  where  $t$  is the time taken for the ball to fall.

..... A light gate is to be attached to the end of the table using  
 ..... A light gate is to be attached to the end of a table

..... a clamp. using a clamp. A set of rulers are to be laid on the table

..... parallel to one another to provide the ball with a straight  
 ..... line of motion. ~~A light gate is to be attached to the end of the table~~ The time taken

..... for the ball to fall and hit the ground is measured  
 ..... using a digital stop watch (with milliseconds to

..... reduce ~~the~~ absolute uncertainties) When the ball  
 ..... leaves the surface of the table, the <sup>stop watch</sup> ~~stop watch~~ is started,

..... it is then stopped when the ball falls and hits the ground.



$$x = v \cdot t \quad x \text{ dv}$$

$$\frac{x}{v} = t$$

$$x = v \cdot t \quad x = v \cdot t$$
$$\frac{x}{t} = v$$

13

~~The ball is to be pushed through a distance of 1m and passes~~  
~~the light gates~~ The distance between the light  
gates should be measured using a metric ruler of  
1mm increments and entered into the software.

This will calculate the speed of the ball before it  
falls. (The last light gate is to be at the edge of the table)

The experiment is repeated for multiple speeds. A graph of  
t against v is to be plotted.

$$\uparrow$$
  
$$v \cdot t = x$$

The experiment is to be carried out safely by ensuring  
that no feet are near the balls landing zone and  
that the ball used is not too heavy.

$$\text{As } v = x \cdot t$$

$$\frac{v}{t} = x$$

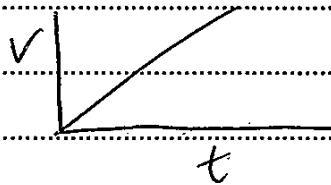

straight line through  
the origin.

indicates that  $v \propto t$ .

[6]



- 17 (a) Phobos is one of the two moons orbiting Mars. Fig. 17.1 shows Phobos and Mars.

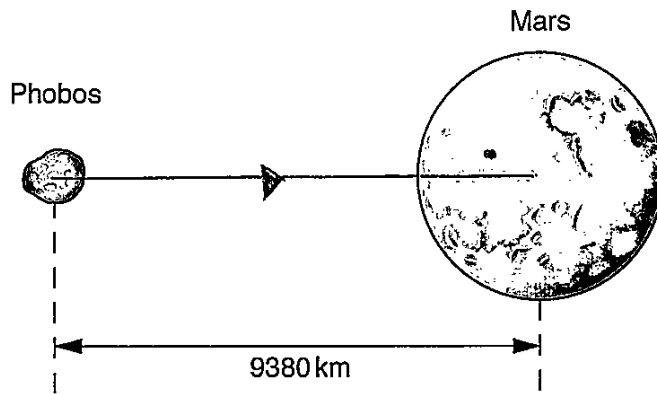

Fig. 17.1

The orbit of Phobos may be assumed to be a circle. The centre of Phobos is at a distance 9380 km from the centre of Mars and it has an orbital speed  $2.14 \times 10^3 \text{ m s}^{-1}$ .

- (i) On Fig. 17.1, draw an arrow to show the direction of the force which keeps Phobos in its orbit. [1]

- (ii) Calculate the orbital period  $T$  of Phobos.

$$T^2 = \frac{4\pi^2 r^3}{GM}$$

$$v = \frac{2\pi r}{t}$$

$$v = \frac{2\pi r}{t}$$

$$v = \frac{2\pi r}{t}$$

$$t = \frac{2\pi r}{v}$$

$$T = \frac{4\pi^2 \times (9380 \times 10^3)^3}{GM}$$

$$t = \frac{2\pi \times (9380 \times 10^3)}{2.14 \times 10^3} = 27540.31691 = 2.8 \times 10^4 \text{ (2sf)}$$

$$T = 2.8 \times 10^4 \text{ s [2]}$$

- (iii) Calculate the mass  $M$  of Mars.

$$T^2 = \frac{4\pi^2 r^3}{GM}$$

$$M = \frac{4\pi^2 r^3}{GT^2}$$

$$M = \frac{4\pi^2 \times (9380 \times 10^3)^3}{6.67 \times 10^{-11} \times (2.7540 \times 10^4)^2} = 6.44 \times 10^{23} \text{ kg.}$$

$$M = 6.4 \times 10^{23} \text{ kg [3]}$$



(b) The gravitational field strength at a distance  $r$  from the centre of Mars is  $g$ .

The table below shows some data on Mars.

$g/\text{N kg}^{-1}$	$r/\text{km}$	$\lg(g/\text{N kg}^{-1})$	$\lg(r/\text{km})$
1.19	6000	0.076	3.78
0.87	7000	<del>-0.060</del>	3.85
0.67	8000	-0.174	3.90
0.53	9000	-0.276	3.95
0.43	10000	-0.367	4.00

(i) Complete the table by calculating the missing values.

[1]

(ii) Fig. 17.2 shows the graph of  $\lg(g/\text{N kg}^{-1})$  against  $\lg(r/\text{km})$ .

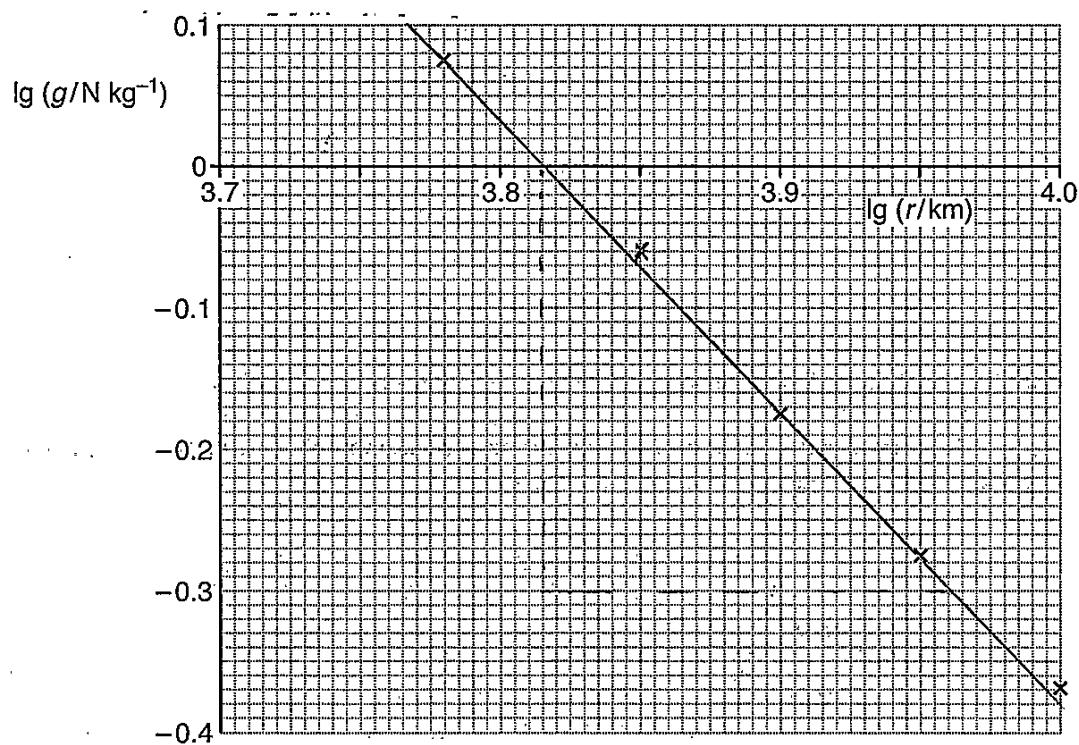

Fig. 17.2

1 Plot the missing data point on the graph and draw the straight line of best fit.

[2]

$$\text{missing data} = (3.85, -0.060)$$



- 2 Use Fig. 17.2 to show that the gradient of the straight line of best fit is  $-2$ .

$$\text{Gradient} = \frac{\Delta y}{\Delta x} = \frac{-0.3 - 0}{3.960 - 3.815} = -2.068965517 \approx -2.$$

[1]

- 3 Explain why the gradient of the straight line of best fit is  $-2$ .

$$g = \frac{GM}{r^2}$$

$$\log(g) = \log\left(\frac{GM}{r^2}\right)$$

$$\log(g) = \log(GM) - \log(r^2)$$

$$\log(g) = \log(GM) - 2\log(r)$$

$$y = \text{---} - 2x$$

$$y = \text{---} - 2x \quad \log(r) = x$$

$$\text{Thus } m = -2 \log(r) \therefore \text{gradient} = -2.$$

[2]

- (c) In July 2018, the closest distance between the centre of Mars and the centre of Earth will be  $5.8 \times 10^{10}$  m.

Fig. 17.3 shows the variation of the **resultant** gravitational field strength  $g$  between the two planets with distance  $r$  from the centre of the **Earth**.

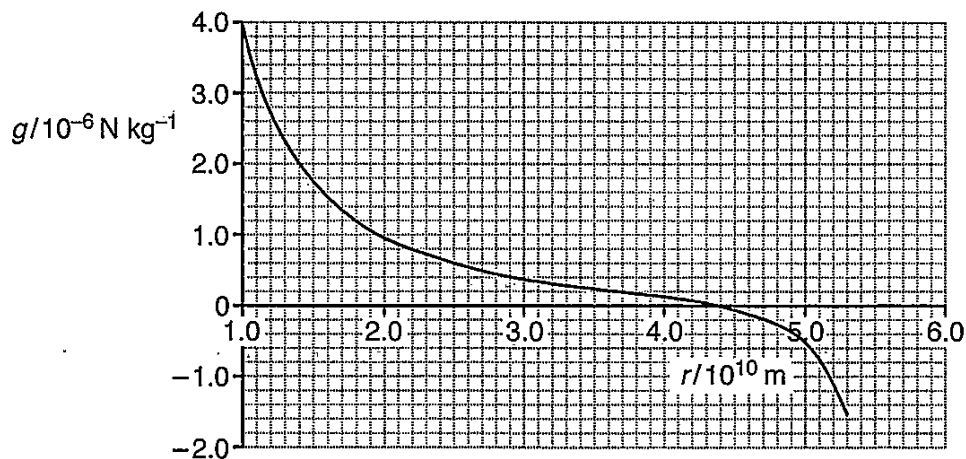

Fig. 17.3





- (i) Explain briefly the overall shape of the graph in Fig. 17.3.

As the point gets further away from earth, the net  $g$  decreases (as  $g \propto \frac{1}{r^2}$ ). The axis is where at the point the force of  $g$  due to earth is equal to that due to the

..... [2]

- (ii) Use the value of  $r$  when  $g = 0$  from Fig. 17.3 to determine the ratio

$$\frac{\text{mass of Earth}}{\text{mass of Mars}}$$

when  $g = 0$ ,  $r = 1 \times 10^{10} \text{ m}$ .

$$\frac{\text{mass of Earth}}{\text{mass of Mars}} = \dots\dots\dots [2]$$



- 18 Wind turbines convert the kinetic energy of the wind into electrical energy. Fig. 18 shows a wind turbine.

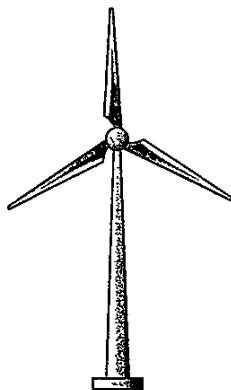

Fig. 18

- (a) When the wind speed is  $8.0 \text{ ms}^{-1}$ , the kinetic energy of the air incident at the turbine per second is  $1.2 \text{ MJ s}^{-1}$ .  
Calculate the mass of the air incident at the turbine per second.

$$\frac{1}{2} \times m \times 8^2 = 1.2 \times 10^6$$

$$m = \frac{2 \times 1.2 \times 10^6}{8^2} = 37500 = 3.8 \times 10^4 \text{ kg}$$

mass per second =  $3.8 \times 10^4$  .....  $\text{kgs}^{-1}$  [2]

- (b) A group of engineers are investigating the design of wind turbines. The maximum **input** power  $P$  from the wind is given by the equation

$$P = \frac{1}{2} \rho A v^3$$

where  $A$  is the area swept out by the rotating blades,  $\rho$  is the density of air and  $v$  is the speed of the wind.

$$\text{den} = \frac{m}{v}$$

$$P = \frac{\text{kg}}{\text{m}^3} \quad v = \text{ms}^{-1}$$

$$v = \text{ms}^{-1}$$

$$v^3 = \text{m}^3 \text{ s}^{-3}$$



$$F = ma$$

$$\text{kg ms}^{-2}$$

$$J = \text{kg ms}^{-2} \times \text{m} =$$

(i) Show that the equation is homogeneous with both sides of the equation having the same base units.

$$P = \frac{1}{2} \rho A v^3$$

$$\frac{J}{s^{-1}} = \frac{1}{2} \times \frac{\text{kg}}{\text{m}^3} \times \text{m}^2 \times (\text{ms}^{-1})^3$$

$$\frac{J}{s^{-1}} = \frac{\text{kg m}^2 \times \text{m}^3 \times \text{s}^{-3}}{\text{m}^3}$$

$$\frac{\text{kg m}^2}{\text{s}^{-2} \times \text{s}^{-1}} = \frac{\text{kg m}^2 \times \cancel{\text{m}^3} \times \cancel{\text{s}^{-3}}}{\cancel{\text{m}^3} \times \text{s}^{-3}}$$

$$\frac{\text{kg m}^2}{\text{s}^{-3}} = \frac{\text{kg m}^2}{\text{s}^{-3}} \therefore \text{equation is homogeneous.}$$

[3]

(ii) The input power to the wind turbine is 1.2 MW when the wind speed is 8.0 m s<sup>-1</sup>. The density of air is 1.3 kg m<sup>-3</sup>.

Calculate the length L of the turbine blades:

$$1.2 \times 10^6 = \frac{1}{2} \times 1.3 \times L \times$$

Mass of air = 375000 kg

$$D = \frac{M}{V}$$

$$V = \frac{M}{D}$$

$$V = \frac{375000}{1.3} = 288460$$

density

kg

~~length × height × width~~

$$\frac{1.2 \times 10^6 \times 2}{1.3 \times 8^2} = 28846$$

$$28846 \times 10^3 \text{ m}^2$$

$$L = 170 \text{ m} \dots \dots \dots \text{m [2]}$$

(iii) A wind farm is required to produce an output power of 50 MW when the average wind speed is 8.0 m s<sup>-1</sup>. The efficiency of each wind turbine is 42%.

Calculate the minimum number N of wind turbines required to meet this demand.

Input E = 1.2 × 10<sup>6</sup> W

Output E = 50 × 10<sup>6</sup> W

$$x = 5.04 \times 10^5 \text{ W}$$

$$\frac{50 \times 10^6}{5.04 \times 10^5} = 99 \text{ turbines}$$

$$\approx 100$$

$$\frac{x}{1.2 \times 10^6} = 0.42$$

$$0.42 \times 1.2 \times 10^6 = x$$

$$N = 100 \dots \dots \dots [2]$$

Turn over



19 Fig. 19 is an incomplete Hertzsprung-Russell (HR) diagram of stars in our galaxy.

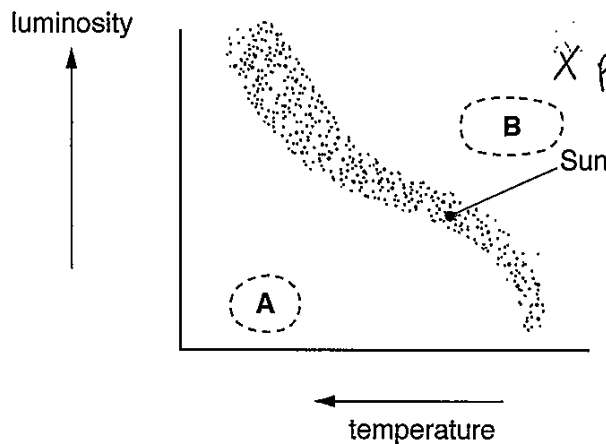

Fig. 19

The position of the Sun on the HR diagram is shown in Fig. 19.

(a) State the type of stars found in regions A and B.

A ..... white dwarfs ..... B ..... red giants ..... [1]

(b) The Sun is a main sequence star. Its surface temperature is 5800K. The wavelength of the emitted light at maximum intensity is 550nm.

Beta Pictoris is also a main sequence star. The wavelength of the emitted light at maximum intensity from this star is 370 nm.

(i) Calculate the surface temperature of Beta Pictoris.

$$\lambda_{\max} \propto \frac{1}{T}$$

$$\lambda_{\max} T = k.$$

$$5800 \times 550 \times 10^{-9} = 3.19 \times 10^{-3}$$

$$T = \frac{k}{\lambda_{\max}}$$

$$T = \frac{3.19 \times 10^{-3}}{370 \times 10^{-9}}$$

$$T = 8621 \approx 8600 \text{ (2sf)}$$

temperature = ..... 8600 ..... K [2]

(ii) On Fig. 19, mark the likely position of Beta Pictoris with a letter P. [1]



20 (a) Use the equations for momentum and kinetic energy to derive an expression for the kinetic energy  $E_k$  of a particle in terms of its momentum  $p$  and mass  $m$ .

(p) Momentum = mass  $\times$  velocity

$$KE = \frac{1}{2} \times \text{mass} \times \text{velocity}^2$$

$$\frac{p}{m} = v \rightarrow \frac{p^2}{m^2} = v^2$$

$$KE = \frac{1}{2} \times m \times \left(\frac{p}{m}\right)^2$$

~~$\therefore KE = \frac{1}{2} \times \frac{p^2}{m}$~~

$\therefore KE = \frac{m p^2}{2 m^2}$

~~$\therefore KE = \frac{p v}{2 m}$~~

$\therefore KE = \frac{p^2}{2 m}$

[2]

(b) Fig. 20.1 shows an electric motor used to lift and lower a load.

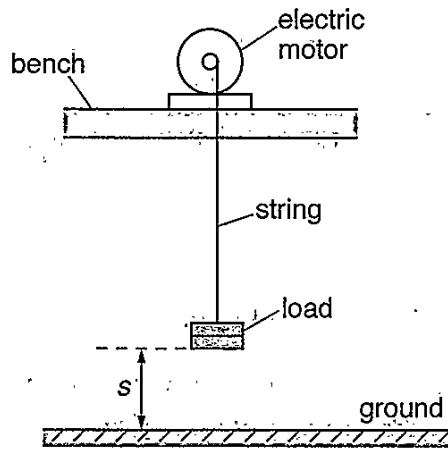
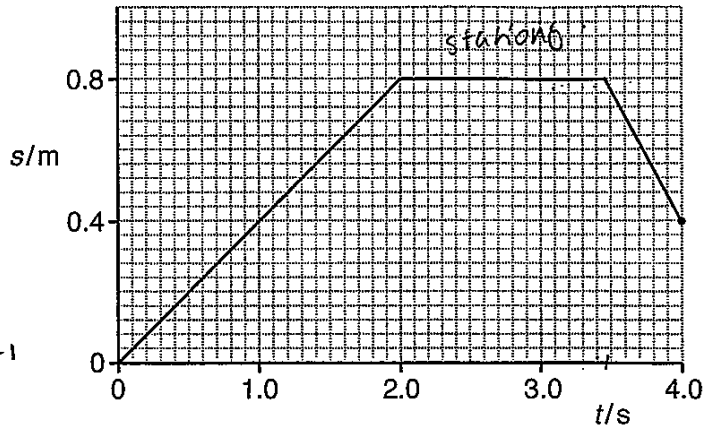

Fig. 20.1



At time  $t = 0$  the load is on the ground with displacement  $s = 0$ .  
Fig. 20.2 shows the variation of the displacement  $s$  of the load with time  $t$ .



gradient =  $v$   
 $\frac{0.8}{2} = 0.4 \text{ ms}^{-1}$

$\frac{-0.4}{0.55} = 0.727$   
 $= -9.727$

Fig. 20.2

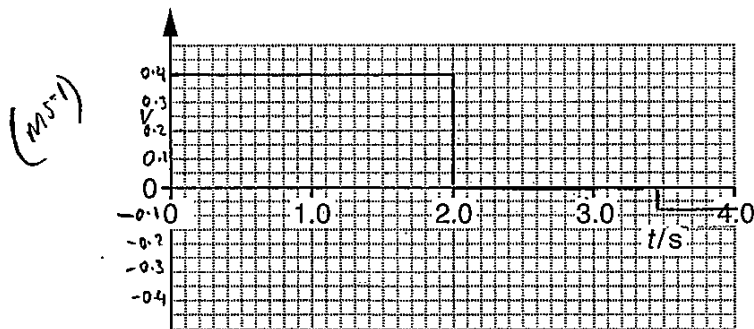

Fig. 20.3

- (i) On Fig. 20.3, sketch a graph to show the variation of the velocity  $v$  of the load with time  $t$ . You do not need to insert a scale on the  $v$  axis. [3]
- (ii) Describe how the kinetic energy and the gravitational potential energy of the load varies from  $t = 0$  to  $t = 2.0$  s.

From 0 to 2.0 seconds, the load's gravitational potential energy increases as its height increases.  
 At  $t = 2$  seconds its kinetic energy is zero and its gravitational potential energy is ~~at~~ at its max [2]



- (iii) During the **downward** journey of the load, the string breaks at  $t = 4.0\text{s}$ . It then falls vertically towards the ground. The mass of the load is 120g. Air resistance is negligible.

1 Calculate the velocity  $V$  of the load just before it hits the ground.

~~0.24~~

$s = 0.4$   
 $u = \frac{0.4}{0.55}$   
 $v = ?$   
 $a = 9.81$   
 $t =$

$$v^2 = u^2 + 2as$$

$$v = \sqrt{\left(\frac{0.4}{0.55}\right)^2 + 2 \times 9.81 \times 0.4} = 2.89429$$

$$\approx 2.9 \text{ ms}^{-1}$$

$$v = \underline{2.90} \text{ ms}^{-1} [2]$$

2 The load hits the ground and comes to rest in a time interval of 25 ms.

Calculate the average force  $F$  exerted by the ground on the load.

$$F = \frac{m(v-u)}{t}$$

$$F = \frac{0.120(0 - 2.894291903)}{25 \times 10^{-3}} = 13.89260113$$

$$\approx 14 \text{ N}$$

$$F = \underline{14} \text{ N} [2]$$



21 Fig. 21 shows the drum of a washing machine.

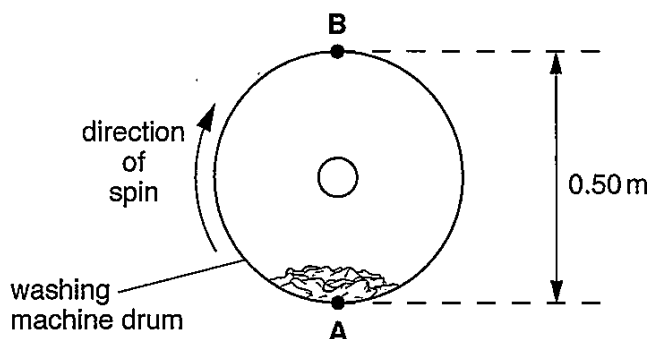

Fig. 21

The clothes inside the drum are spun in a **vertical** circular motion in a clockwise direction.

- (a) When the drum is at rest, the weight of the clothes is equal to the normal contact force on the clothes at point A.

Explain why these two forces are not an example of Newton's Third Law of motion.

Newton's 3<sup>rd</sup> law states that objects exert an equal and opposite force on one another. However, this is not the case while the drum is rotating. When at its highest point, the normal contact force is less than the weight in order to produce a resultant downwards force to allow circular motion, vice versa for the bottom. [2]  
(resultant force = centripetal force)

- (b) The drum has diameter 0.50 m. The manufacturer of the washing machine claims that the drum spins at  $1600 \pm 100$  revolutions per minute.

Calculate the speed of rotation of the drum and the absolute uncertainty in this value.

$$v = \frac{2\pi r}{t}$$

$$v = 2\pi f r$$

$$v = 2\pi \times \frac{80}{3} \times 0.25$$

$$v = 41.887$$

$$\approx 42$$

1600 revs = 1 min.  
 $\frac{80}{3} = 1 \text{ second}$   
 $f = \frac{80}{3}$   
 $\frac{100}{1600} \times \frac{42}{100} = 2.6179$

speed =  $42 \pm 2.6 \text{ ms}^{-1}$  [3]





- (c) The washing machine is switched off and the speed of the drum slowly decreases. The clothes at the top of the drum at point B start to drop off at a certain speed  $v$ .

At this speed  $v$ , the normal contact force on the clothes is zero.

Calculate the speed  $v$ .

$$F_{\text{net}} = mg > N$$

$$F_{\text{net}} = \frac{mv^2}{r} =$$

$$\frac{mv^2}{r} > mg$$

$$v = \dots\dots\dots \text{ms}^{-1} [3]$$



- 22 (a) A helium atom X travelling at  $610 \text{ m s}^{-1}$  makes an elastic collision with a stationary helium atom Y. The magnitude of the velocity of X after the collision is  $258 \text{ m s}^{-1}$ . The directions of the velocities of X and Y are as shown in Fig. 22.

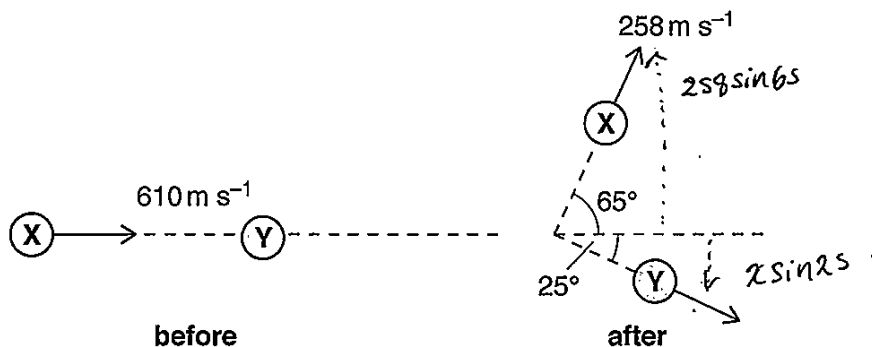

Fig. 22

- (i) Explain what is meant by an *elastic collision*.

A collision in which total energy, momentum and kinetic energy is conserved. [1]

- (ii) The mass of a helium atom is  $6.64 \times 10^{-27} \text{ kg}$ . Calculate the magnitude of the momentum  $p$  of Y after the collision.

Total momentum in  $v_y = 0$ .

$$258 \sin 65 \times 6.64 \times 10^{-27} = x \sin 25 \times 6.64 \times 10^{-27}$$

$$258 \sin 65 = x \sin 25$$

$$\frac{258 \sin 65}{\sin 25} = x = 553.282785$$

$$(610 \times 6.64 \times 10^{-27}) = (258 \sin 65 \times 6.64 \times 10^{-27}) + (x \sin 25 \times 6.64 \times 10^{-27})$$

$$p = 3.3 \times 10^{-21} \text{ kg m s}^{-1} [3]$$

- (b)\* There is a lot of helium in the Universe. This was also true of the Earth when it was formed billions of years ago. However, only small traces of helium are now found in the atmosphere of the Earth.

Use the kinetic theory of gases to explain why only small amounts of helium are found in the Earth's atmosphere. Use the information below to do suitable calculations to support your answer.

- typical atmospheric temperature =  $10^\circ \text{C}$
- mass of helium atom =  $6.64 \times 10^{-27} \text{ kg}$
- escape velocity from the Earth =  $11 \text{ km s}^{-1}$



$$E_k = \frac{3}{2} kT$$

$$E_k = \frac{3}{2} \times 1.38 \times (10+273)$$

$$E_k = 5.858 \times 10^{-21}$$

$$\frac{1}{2} m \bar{c}^2 = 5.858 \times 10^{-21}$$

$$\bar{c} = \sqrt{\frac{2 \times 5.858 \times 10^{-21}}{6.64 \times 10^{-27}}} = 1.33 \text{ km s}^{-1}$$

1.33 km s<sup>-1</sup> is the root mean square speed of helium atoms at this temperature. As this is only the mean, helium atoms with a velocity greater than the escape velocity exist. Therefore helium atoms are able to escape the earth's atmosphere. ~~As~~  
~~As~~ ~~As~~ some helium atoms have a velocity that is less than the escape velocity, they cannot escape the earth's gravitational field and thus remain in the earth's atmosphere.

\* This is because their velocity is ~~greater than the escape~~  
~~As~~ means their kinetic energy is greater than the earth's gravitational energy at its radius.



- 23 (a) According to the Cosmological principle, the Universe is isotropic, homogeneous and the laws of physics are universal.

State what is meant by the term *homogeneous*.

The universe is uniform: there is no edge  
to the universe. [1]

- (b) Astronomers often use absorption spectral lines to determine the relative velocity of distant galaxies. The wavelength of a specific absorption spectral line observed in the laboratory is 280 nm.

The galaxy RXJ1242-11 is 200 Mpc away from the Earth and it has a massive black hole at its centre.

away.

- (i) Calculate in nm the wavelength  $\lambda$  of the same spectral line from RXJ1242-11 when observed from the Earth. Assume the Hubble constant is  $68 \text{ km s}^{-1} \text{ Mpc}^{-1}$ .

$$v = H_0 d$$

$$v = 68 \times 200$$

$$v = 13600 \text{ km s}^{-1}$$

$$v = 13.6 \times 10^6 \text{ m s}^{-1}$$

$$\frac{\Delta \lambda}{\lambda} = \frac{v}{c}$$

$$\Delta \lambda = \frac{v \lambda}{c}$$

$$\Delta \lambda = \frac{13.6 \times 10^6 \times 280 \times 10^{-9}}{3 \times 10^8}$$

$$\Delta \lambda = 1.26 \times 10^{-8}$$

$$280 \times 10^{-9} + (1.26 \times 10^{-8}) = 292.6 \times 10^{-9}$$

$$\lambda = 293 \text{ nm} [3]$$

- (ii) State one of the characteristics of a black hole.

Extremely strong gravitational force, the  
escape velocity is greater than that of the speed  
of light (thus they are dark) [1]



(c) The Universe evolved from the Big Bang.

Describe the evolution of the Universe up to the formation of the first nuclei.

Initially, when the big bang occurred, time and space were created and it was infinitely hot and dense. Then (about  $10^{-39}$  seconds ~~later~~ later) ~~the~~ high energy gamma photons arose and the universe began to expand rapidly. Quarks and leptons were soon formed. They began to gain mass via the higgs boson. Quarks then combined to form hadrons. These hadrons (i.e. protons and ~~neutrons~~ neutrons) then became bound to one another and created the first nuclei.

[4]



- 24 A group of students are conducting an experiment to determine the wavelength of monochromatic light from a laser.

Fig. 24.1 shows the laser beam incident normally at a diffraction grating.

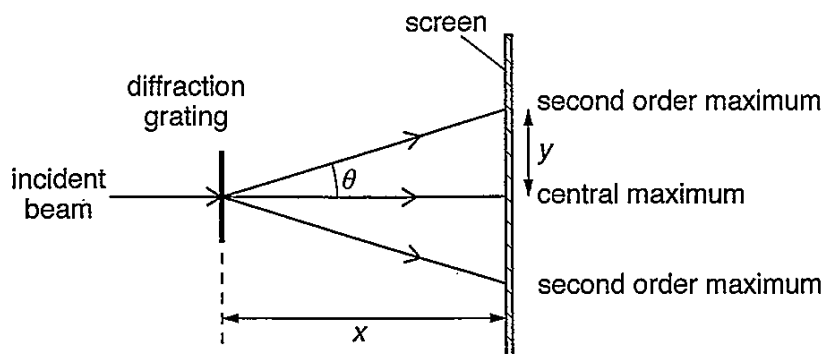
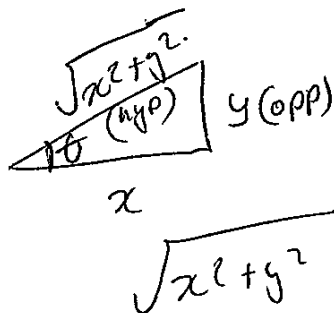

Fig. 24.1

The students use a diffraction grating with  $600 \text{ lines mm}^{-1}$ . They vary the distance  $x$  between the grating and the screen from  $1.000 \text{ m}$  to  $2.000 \text{ m}$ . They measure the distance  $y$  from the **central** maximum to the **second order** maximum.

- (a) The students decide to plot a graph of  $y$  against  $\sqrt{x^2 + y^2}$ .

Show that the gradient of the graph is equal to  $\sin \theta$ , where  $\theta$  is the angle between the central maximum and the **second order** maximum.



[1]

$$\text{gradient} = \frac{y}{\sqrt{x^2 + y^2}}$$

$$\sin \theta = \frac{\text{opp}}{\text{hyp}}$$

$$\sin \theta = \frac{y}{\sqrt{x^2 + y^2}}$$



(b) Fig. 24.2 shows the graph plotted by the students.

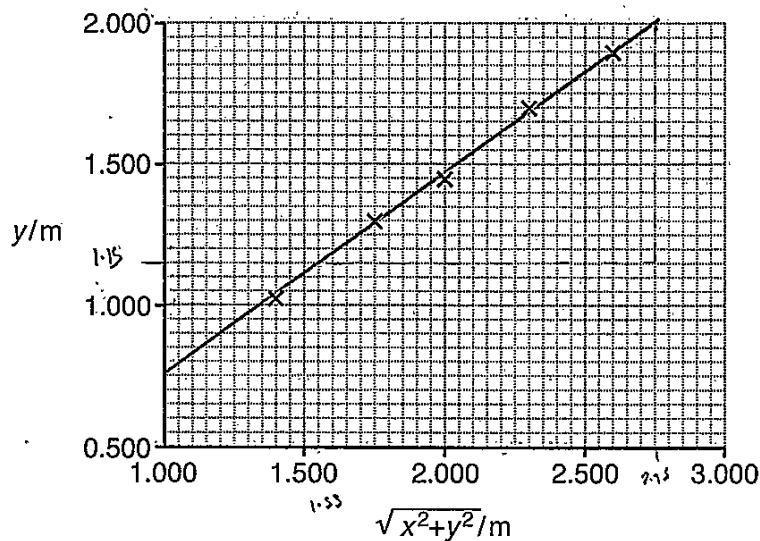

Fig. 24.2

- (i) Use Fig. 24.2 to determine an accurate value of the wavelength  $\lambda$  of the light from the laser.

$$d \sin \theta = n \lambda$$

$$d = \frac{1 \times 10^{-3}}{600} = 1.67 \times 10^{-6}$$

$$\text{Gradient} = \frac{2 - 1.15}{2.75 - 1.55} = 0.70833$$

$$\frac{d \sin \theta}{2} = \frac{2\lambda}{2}$$

$$\frac{1.67 \times 10^{-6} \times 0.708}{2} = \frac{5.902 \times 10^{-7}}{2}$$

$$\lambda = 5.90 \times 10^{-7} \text{ m [3]}$$

- (ii) Suggest why there are no error bars shown in Fig. 24.2.

~~No measurement error~~  
 values are exact / accurate. [1]

- (iii) Suggest how the precision of this experiment may be affected by using a protractor to measure the angle  $\theta$ .

It would be reduced due to possibility of a parallax error. [1]

END OF QUESTION PAPER



## ADDITIONAL ANSWER SPACE

If additional space is required, you should use the following lined page(s). The question number(s) must be clearly shown in the margin(s).

22a(ii)

~~mass~~ ~~total~~ ~~work~~ in  $v_y = 258 \sin 65^\circ$ .

$$v_x: (610 \times 6.64 \times 10^{-27}) = (6.64 \times 10^{-27} \times 258 \cos 65^\circ) +$$

$$(\cancel{6.64 \times 10^{-27} \times 258})$$

$$\sqrt{\left(\frac{258 \sin 65^\circ}{6.64 \times 10^{-27}}\right)^2 + \left(\frac{553 \times 10525}{6.64 \times 10^{-27}}\right)^2} = 3.3 \times 10^{-21}$$

# OCR

Oxford Cambridge and RSA

## Copyright Information

OCR is committed to seeking permission to reproduce all third-party content that it uses in its assessment materials. OCR has attempted to identify and contact all copyright holders whose work is used in this paper. To avoid the issue of disclosure of answer-related information to candidates, all copyright acknowledgements are reproduced in the OCR Copyright Acknowledgements Booklet. This is produced for each series of examinations and is freely available to download from our public website ([www.ocr.org.uk](http://www.ocr.org.uk)) after the live examination series.

If OCR has unwittingly failed to correctly acknowledge or clear any third-party content in this assessment material, OCR will be happy to correct its mistake at the earliest possible opportunity.

For queries or further information please contact the Copyright Team, First Floor, 9 Hills Road, Cambridge CB2 1GE.

OCR is part of the Cambridge Assessment Group; Cambridge Assessment is the brand name of University of Cambridge Local Examinations Syndicate (UCLES), which is itself a department of the University of Cambridge.

